



SOLUTIONS SUR MESURE

La satisfaction du Client est notre devise.
Nous ne livrons d'ailleurs que du matériel de qualité,
avec un support professionnel et un conseil adéquat.

www.bpc-international.com







Bref aperçu de la gamme:

	Pompes à haute / à ultrahaute pression Accessoires	Page 2 - 4 Page 5 - 7
	Pompes à haute pression	Page 8
	Hydrocureurs - Recycleurs	Page 9
	Balayuses-aspiratrices	Page 10
		Page 11
	Accessoires nettoyage de canalisations	Page 12
	Obturateurs dilatables Tuyaux flexibles pour canalisations	Page 13 Page 13
	Suppression de poussière	Page 14





POMPES INDUSTRIELLES A HAUTE & ULTRA-HAUTE PRESSION

Fluides:	Eau (également eau chaude et eau de mer) & fluides process
Pression de travail:	25 - 4000 bar
Débit:	2 - 2987 l/min
Puissance:	5 - 1100 kW
Entraînement:	Moteur électrique (avec / sans régulateur de fréquence) ou moteur diesel , également 
Exécutions:	Arbre libre, skid, remorque, container machine 10' / 20' / 40', Off-Shore 
Applications:	Nettoyage industriel & maritime Rénovation de béton / Hydrodémolition Décapage de peinture Nettoyage de citernes & reacteurs  Découpe à jet d'eau (avec / sans abrasif) Débavurage Plusieurs applications dans l' industrie Process  Off-shore 

HAMMELMANN®

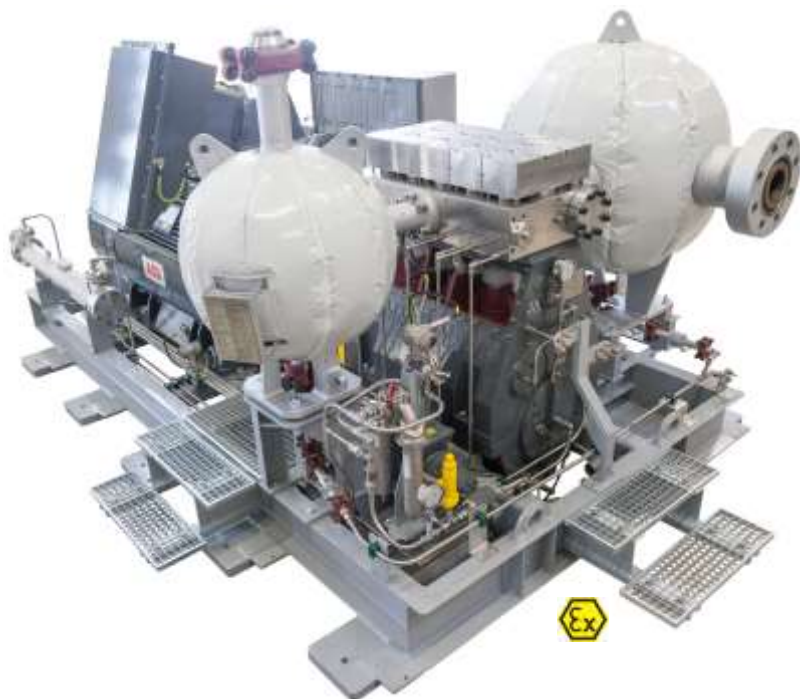

AVEC ENTRAÎNEMENT A MOTEUR DIESEL



POMPE PROCESS



ENTRAÎNEMENT A MOTEUR ELECTRIQUE

HAMMELMANN®



INSTALLATION AUTONOME ET INSONNORISEE SUR REMORQUE



INSTALLATION AUTONOME DANS CONTAINER MACHINE INSONNORISEE

HAMMELMANN®

DECAPAGE

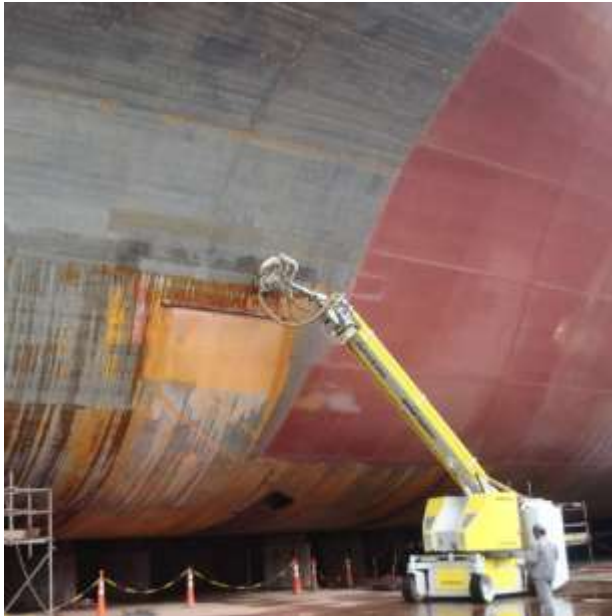

DOCKMATE®



SPIDERJET®



AQUABLAST®-PLUS



MASTERJET®



PISTOLETS HP & UHP



DÉCOUPE A JET D'EAU



ACIER



MUR EN BETON ARME



PLATEAU EN BETON ARME

NETTOYAGE DE CITERNE / RÉACTEUR

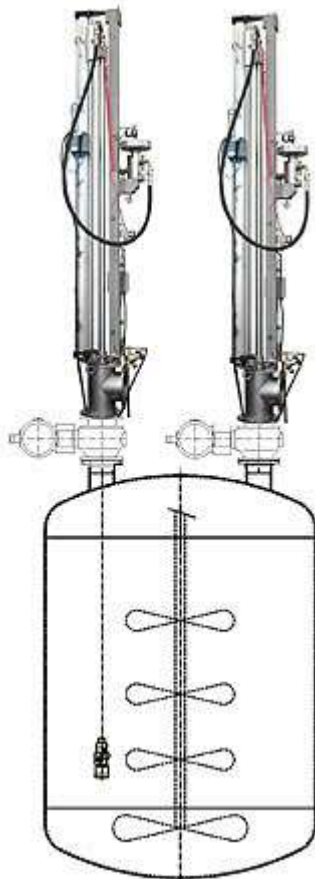

TÊTE DE NETTOYAGE AVEC LANCE DANS RÉACTEUR



QUELQUES MODÈLES DE LA GAMME



POMPES A HAUTE PRESSION

Pression: **110 à 1500 bar**
 Débit: **7 à 620 l/min**
 Puissance: **3 à 237 kW**
 Exécution: **Arbre libre ou avec moteur hydraulique**
 Applications: **Nettoyage industriel, hydrocuvrage**



ACCESSOIRES

Vannes de régulation de pression, de bypass, de surpression, non-retour, accumulateurs, ...





HYDROCUREURS SPECIALITÉ = **RECYCLEURS**

" **QUI FAIT MIEUX ?????** "

ON TROUVE BEAUCOUP DE "SOI DISANT" RECYCLEURS SUR LE MARCHÉ MAIS PEU SAVENT GARANTIR LA MEME QUALITE D'EAU DES RECYCLEURS **KROLL !!!**



Exemple d'exécution:

Capacité de recyclage:	+/- 550 l/min
Pompe à vide:	CVS VACUSTAR WR 3100
Pompe HP 1:	HAMMELMANN HDP146 // 407 l/min @ 200 bar
Pompe HP 2:	PRATISSOLI KF 30 // 106 l/min @ 200 bar
Enrouleur principal:	200 m DN 32
Petit enrouleur:	80 m DN12
Cassette:	Tuyau d'aspiration DN150



**BALAYEUSES-ASPIRATRICES – UNITES POUR DEMARCAGE
BOÎTE HYDROSTATIQUE "VALMETAL"**



TÊTES DE NETTOYAGE, ACCESSOIRES ET OUTILS POUR LE CURAGE DE CANALISATIONS "SWISS QUALITY"

Têtes standards



Têtes à haut rendement



Têtes prismoïdales



Nettoyeurs à radiers



Têtes rotatives / vibrantes
Têtes à vitesse réduite Bulldog®



Têtes à chaînes



Fraises

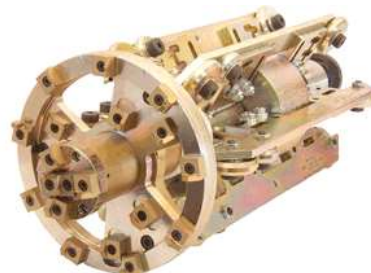

Coffrets pratiques de stockage





OBTURATEURS DILATABLES



Standard à partir de DN 100 - DN 1200 // **3 bar**
Exécution spéciale jusqu'à DN 2400

(!)

TUYAUX DE CURAGE A FAIBLE POIDS **CANALKLER 250 S**



A partir de DN12 (1/2") jusqu'à DN38 (1 1/2") // DN32 (1 1/4") jusqu'à 200 m

dustcruster®

SUPPRESSION DE POUSSIÈRE



Suppression de poussière extrêmement effective sur des produits en vrac
Sans utilisation de produit chimique

Résiste aux intempéries

Déjà utilisé dans le monde entier



Matière à réfléchir:

*Ce n'est pas intelligent de payer trop,
mais, c'est encore plus grave de payer trop peu.*

*Si tu paies de trop, tu perds un peu d'argent,rien de plus.
Si tu paies trop peu tu perds peut-être tout puisque ce que tu as acheté n'est
pas en mesure de réaliser ce que tu avais prévu de faire.*

*En affaires, il n'est pas possible de payer peu et de recevoir beaucoup.
Ceux qui préfère le bas prix, feront bien de prévoir une somme de réserve pour
couvrir le risque.*

Et, dans ce cas, autant acheter directement le produit plus cher.