



## **OPLOSSINGEN OP MAAT**

Klanttevredenheid is ons Leitmotiv, wij leveren dan ook uitsluitend kwalitatief materiaal én de daarbijhorende ondersteuning én professioneel advies.



[www.bpc-international.com](http://www.bpc-international.com)

Beknopt overzicht van het gamma:

	<p>Hoge- en Ultrahogedruk pompen Toebehoren</p>	<p>Pag. 2 t/m 4 Pag. 5 t/m 7</p>
	<p>Hogedruk pompen</p>	<p>Pag. 8</p>
	<p>Rioolcombi's – Recyclers</p>	<p>Pag. 9</p>
	<p>Veegwagens * Wegdekreinigers</p>	<p>Pag. 10</p>
	<p>Robots voor Hydrodemolition</p>	<p>Pag. 11</p>
	<p>Rioolspuitkoppen en meer...</p>	<p>Pag. 12</p>
	<p>Opblaasbare leidingstoppers Rioolspoelslangen</p>	<p>Pag. 13 Pag. 13</p>
	<p>Stofbestrijding</p>	<p>Pag. 14</p>





## INDUSTRIËLE HOGE- & ULTRAHOGEDRUK PLUNJERPOMPEN

Uitvoeringen:	<b>Water</b> ( ook <b>warmwater</b> en <b>zeewater</b> ) & <b>processmedia</b>
Werkdruk:	<b>25 tot 4000 bar</b>
Debiet:	<b>2 tot 2987 l/min</b>
Vermogen:	<b>5 tot 1100 kW</b>
Aandrijving:	<b>E-motor</b> ( met / zonder frequentiesturing ) of <b>dieselmotor</b>
Uitvoering:	<b>Vrije as, skid, aanhangwagen, machinecontainer 10' tot 40'</b>
Toepassingen:	<b>Industriële- &amp; Scheepsreiniging</b> <b>Betonrenovatie</b> <b>Ontlakken</b> <b>Tankwas &amp; Reactorreiniging</b>  <b>Waterstraal snijden</b> ( met / zonder abrasief ) <b>Ontbramen</b> ..... <b>Veelvuldige toepassingen in de Process industrie</b>  <b>Off-shore</b> 

**HAMMELMANN®**

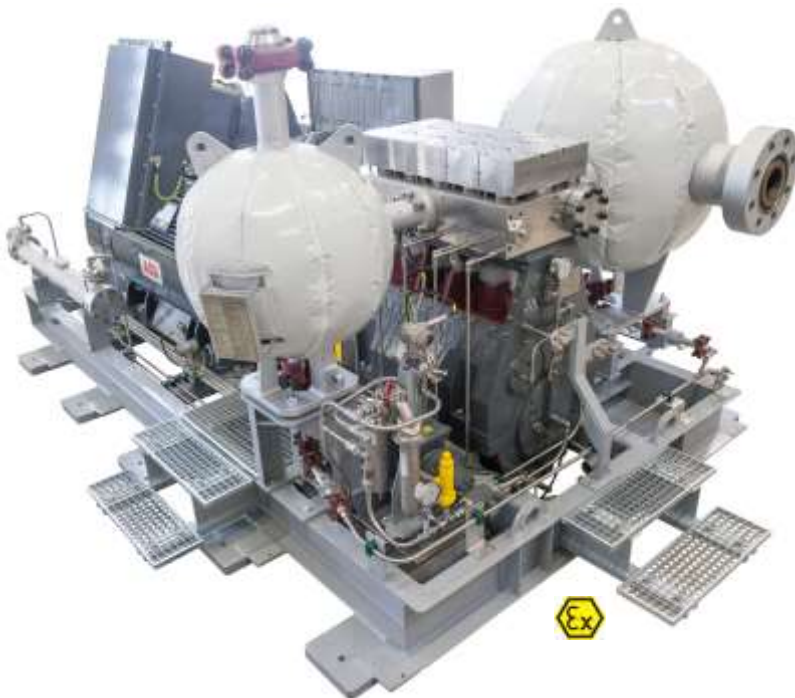

MET DIESELMOTOR AANDRIJVING



PROCESSPOMP



MET ELECTROMOTOR AANDRIJVING

**HAMMELMANN®**



AUTONOME INSTALLATIE IN GELUIDGEDEMPTE AANHANGER



AUTONOME INSTALLATIE IN GELUIDGEDEMPTE MACHINECONTAINER

# HAMMELMANN®

## VERF VERWIJDEREN / ONTLAKKEN

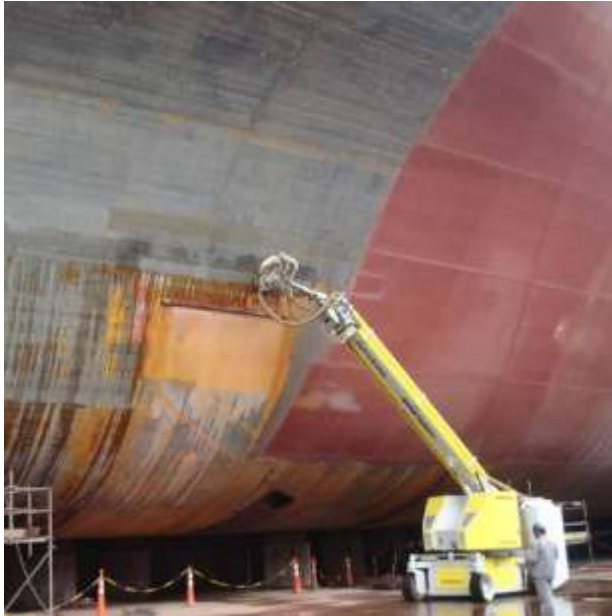

DOCKMATE®



SPIDERJET®



AQUABLAST®-PLUS



MASTERJET®



HD & UHD PISTOLEN



## WATERSTRAAL SNIJDEN



STAAL



MUUR UIT GEWAPEND BETON



PLATEAU UIT GEWAPEND BETON

## TANKWAS / REACTOR REINIGEN

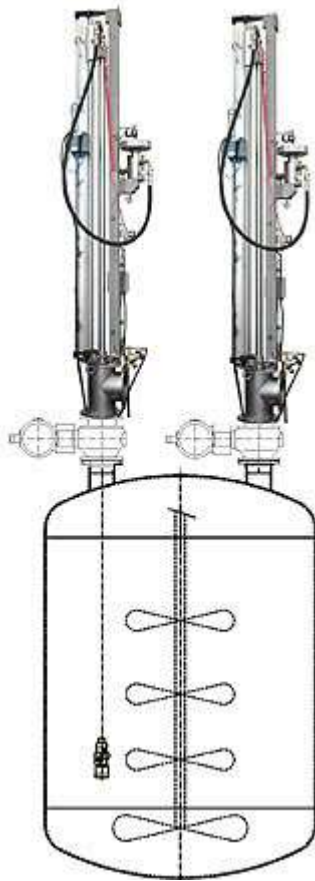

TANKWASKOP MET LANS IN REACTOR



GREEP UIT HET GAMMA TANKWASKOPPEN





## HOGEDRUK PLUNJERPOMPEN

Werkdruk: **110 tot 1500 bar**  
 Debiet: **7 tot 620 l/min**  
 Vermogen: **3 tot 237 kW**  
 Uitvoering: **Vrije as of met hydromotor**  
 Toepassingen: **Industriële reiniging, rioolreiniging**



## TOEBEHOREN

Drukregel- en bypassventielen \* Overdrukventielen \* Terugslagkleppen \* Pulsatiedempers \* ...





## VOERTUIGEN VOOR INDUSTRIËLE- EN RIOOLREINIGING SPECIALITEIT = **RECYCLERS**

*"VELEN ZIJN GEROEPEN, WEINIGEN ZIJN UITVERKOREN"*

ER ZIJN INDERDAAD HEEL WAT ZOGENAAMDE RECYCLERS OP DE MARKT DOCH WEINIGEN KUNNEN ZICH METEN MET DE WATERKWALITEIT DIE **KROLL** KAN LEVEREN !!!



Mogelijke parameters:

Recyclagecapaciteit:	ca 550 l/min
Vacuümpomp:	CVS VACUSTAR WR 3100
HD pomp 1:	HAMMELMANN HDP146 // 407 l/min @ 200 bar
HD pomp 2:	PRATISSOLI KF 30 // 106 l/min @ 200 bar
Groot HD haspel:	200 m DN 32
Klein HD haspel:	80 m DN12
Cassette:	Zuigslang DN150



**VEEGWAGENS - HD WEGDEKREINIGERS - DEMARCAGE  
"VALMETAL" HYDROSTATISCHE AANDRIJVING**





**ROBOTS VOOR BETONRENOVATIE  
DE **PIONIER** VAN DE HYDRODEMOLITION TECHNIEK**



## SPUITKOPPEN EN WERKTUIGEN VOOR RIOOL/BUISREINIGING "SWISS QUALITY"

Standaard spuitkoppen



Hoogrendement spuitkoppen



Prismoïdale spuitkoppen



Bodemreinigers



Roterende spuitkoppen / Ook vibrerende  
Traagdraaiende Bulldog® spuitkop



Kettingslingers



Frezen

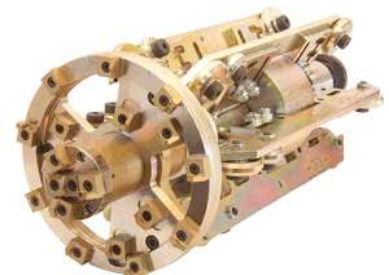

Handige opbergkoffers



## OPBLAASBARE LEIDINGSTOPPERS



Standaard vanaf DN 100 tot DN 1200 // **3 bar** (!)  
Speciale uitvoeringen tot DN 2400

## LICHTGEWICHT RIOOLSPOELSLANGEN **CANALKLER 250 S**



Vanaf DN12 ( ½" ) tot DN38 ( 1 ½" ) // DN32 ( 1 ¼" ) tot 200 meter

# dustcruster®

## STOFBESTRIJDING



Uiterst effectieve stofbestrijding op bulkproducten zonder gebruik van chemicaliën

Weerstaat weer en wind

Wereldwijd in gebruik



*Stof tot nadenken:*

*Het is niet verstandig om te veel te betalen,  
doch het is erger om te weinig te betalen.*

*Indien je teveel betaalt verlies je wat geld..., meer niet.  
Wanneer je echter te weinig betaalt verlies je misschien alles, want het ding dat  
je kocht was niet in staat om te doen wat het verondersteld werd te moeten  
doen.*

*Zakelijk gesproken is het niet haalbaar om weinig te betalen en veel te krijgen.  
Indien je te doen hebt met de laagste prijs is het niet onverstandig om wat extra  
te voorzien om het risico af te dekken.*

*En, indien je dit doet, heb je beslist voldoende om het betere te betalen.*